

## MINIATURE SIZE GYRO SENSOR (FOR CAR NAVIGATION SYSTEM) XV-8000CB / LK



Product number (please contact us)  
XV-8000CB: Q71800020xxxx00  
XV-8000LK: X2A000011xxxx00

- 5.0V operable device (Ratio metric output)
- High stability using vibration crystal
- With output terminal of temperature sensor
- External dimensions: 5.0 x 3.2 x 1.3 mm ... XV-8000CB  
6.0 x 4.8 x 3.3 mm ... XV-8000LK
- Inclined angle: 20 degrees (XV-8000LK)

### Recommended Application

- Car navigation system

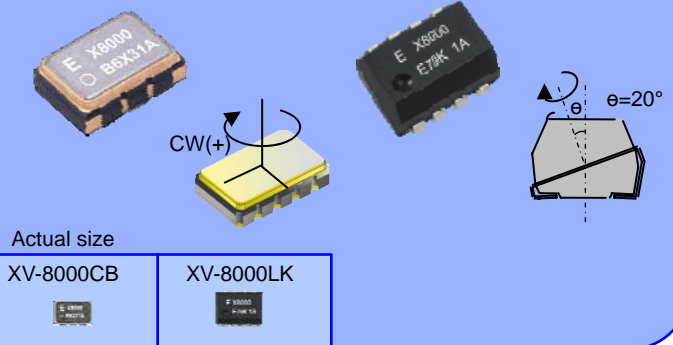

Actual size

XV-8000CB

XV-8000LK

### Specifications (characteristics)

Item	Symbol	Specifications	Remarks
Supply Voltage	VDD	5.0 V $\pm$ 0.25 V	VSS=0 V
Temperature range	Storage Temperature	TSTG	-40 °C to +85 °C
	Operating Temperature	TOPR	-40 °C to +85 °C
Scale factor	So	25 mV/(°·s <sup>-1</sup> ) Typ.	
Bias	V <sub>0</sub>	50 % VDD	T <sub>a</sub> =+25 °C
Rate range	I	$\pm$ 60 deg/s	
Non linearity	NI	$\pm$ 0.5 % FS Max.	T <sub>a</sub> =+25 °C
Frequency response	BW	10 Hz Typ.	Phase delay angle 90°
Cross axes	OS	$\pm$ 5 % Max.	T <sub>a</sub> =+25 °C
Current consumption	I <sub>op</sub>	4 mA Typ.	V <sub>0</sub> : Output No load condition
Quiescent noise	rN	3 mVp-p Typ	

### External Dimensions

(Unit:mm)

#### •XV-8000CB

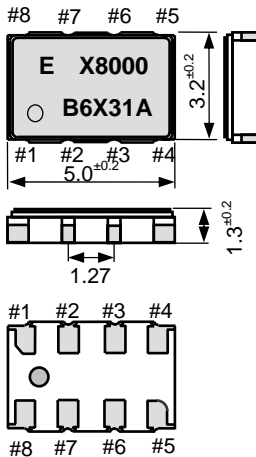

#### •XV-8000LK

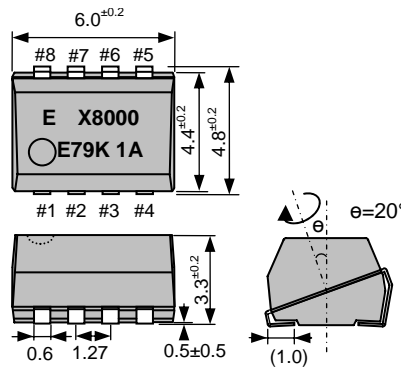

#### Pin map

Pin	Connection
1	N.C.
2	GND
3	VDD
4	N.C.
5	N.C.
6	VOUT
7	VTEMP
8	N.C.

Do not connect "N.C." to external device

### Footprint (Recommended)

(Unit:mm)

#### •XV-8000CB

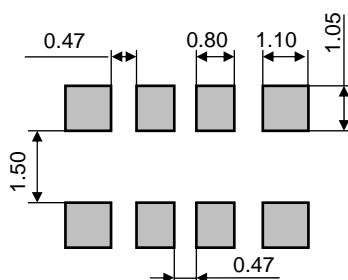

#### •XV-8000LK

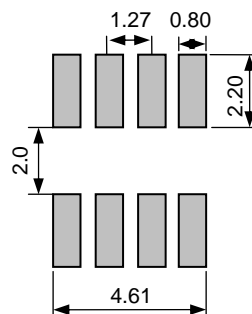

# “QMEMS” EPSON TOYOCOM

In order to meet customer needs in a rapidly advancing digital, broadband and ubiquitous society, we are committed to offering products that are one step ahead of the market and a rank above the rest in quality. To achieve our goals, we follow a “3D (three device) strategy” designed to drive both horizontal and vertical growth. We will to grow our three device categories of “Timing Devices”, “Sensing Devices” and “Optical Devices”, and expand vertical growth through a combination of products from these categories.

A Quartz MEMS is any high added value quartz device that exploits the characteristics of quartz crystal material but that is produced using MEMS (micro-electro-mechanical system) processing technology.

Market needs are advancing faster than previously imagined toward smaller, more stable crystal products, but we will stay ahead of the curve by rolling out products that exceed market speed and quality requirements. We want to further accelerate the 3D strategy by QMEMS.

Quartz devices have become crucial in the network environment where products are increasingly intended for broadband, ubiquitous applications

and where various types of terminals can transfer information almost immediately via LAN and WAN on a global scale. Epson Toyocom Corporation addresses every single aspect within a network environment. The new corporation offers “Digital Convergence” solutions to problems arising with products for consumer use, such as, core network systems and automotive systems.



QMEMS

QMEMS and its logos are registered trademarks or trademarks of Epson Toyocom Corporation in Japan and other countries.

## PROMOTION OF ENVIRONMENTAL MANAGEMENT SYSTEM CONFORMING TO INTERNATIONAL STANDARDS

At Epson Toyocom, all environmental initiatives operate under the Plan-Do-Check-Action(PDCA) cycle designed to achieve continuous improvements. The environmental management system (EMS) operates under the ISO 14001 environmental management standard.

All of our major manufacturing and non-manufacturing sites, in Japan and overseas, completed the acquisition of ISO 14001 certification.

ISO 14000 is an international standard for environmental management that was established by the International Standards Organization in 1996 against the background of growing concern regarding global warming, destruction of the ozone layer, and global deforestation.



## WORKING FOR HIGH QUALITY

In order provide high quality and reliable products and services than meet customer needs,

Epson Toyocom made early efforts towards obtaining ISO9000 series certification and has acquired ISO9001 for all business establishments in Japan and abroad. We have also acquired ISO/TS 16949 certification that is requested strongly by major automotive manufacturers as standard.

ISO/TS16949 is the international standard that added the sector-specific supplemental requirements for automotive industry based on ISO9001.

### ► Explanation of the mark that are using it for the catalog

	► Pb free.
	► Complies with EU RoHS directive. *About the products without the Pb-free mark. Contains Pb in products exempted by EU RoHS directive. (Contains Pb in sealing glass, high melting temperature type solder or other.)
	► The products have been designed for high reliability applications such as Automotive.

## Notice

- This material is subject to change without notice.
- Any part of this material may not be reproduced or duplicated in any form or any means without the written permission of Epson Toyocom.
- The information, applied circuitry, programming, usage, etc., written in this material is intended for reference only. Epson Toyocom does not assume any liability for the occurrence of infringing on any patent or copyright of a third party. This material does not authorize the licensing for any patent or intellectual copyrights.
- Any product described in this material may contain technology or the subject relating to strategic products under the control of the Foreign Exchange and Foreign Trade Law of Japan and may require an export license from the Ministry of International Trade and Industry or other approval from another government agency.
- You are requested not to use the products (and any technical information furnished, if any) for the development and/or manufacture of weapon of mass destruction or for other military purposes. You are also requested that you would not make the products available to any third party who may use the products for such prohibited purposes.
- These products are intended for general use in electronic equipment. When using them in specific applications that require extremely high reliability, such as the applications stated below, you must obtain permission from Epson Toyocom in advance.  
/ Space equipment (artificial satellites, rockets, etc.) / Transportation vehicles and related (automobiles, aircraft, trains, vessels, etc.) / Medical instruments to sustain life / Submarine transmitters / Power stations and related / Fire work equipment and security equipment / traffic control equipment / and others requiring equivalent reliability.
- In this document, product codes and markings will remain as previously identified prior to the merger. Due to the on-going strategy of gradual unification of part numbers, please review product codes and markings.
- All brands or product names mentioned herein are trademarks and/or registered trademarks of their respective companies.